



Part Number: D3MC7011Y-77K

Electrical Specifications

Frequency Range (GHz):	7.75 – 10.80
Isolation (dB):	21 MIN
Insertion Loss (dB):	0.3 MAX
Return Loss (dB):	16 MIN
Forward Power (W):	30 AVG
	30 PK

Mechanical/Environmental Specifications

Connector Type:	SMA
Connector Body:	Passivated stainless steel
Connector Pin:	Gold plated copper
Magnetic Shunt:	Nickel plated CRS
Optimized Temperature:	< 77K
Weight (oz)	0.8 MAX

D3MC7011Y-77K

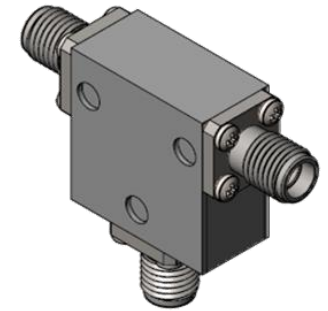
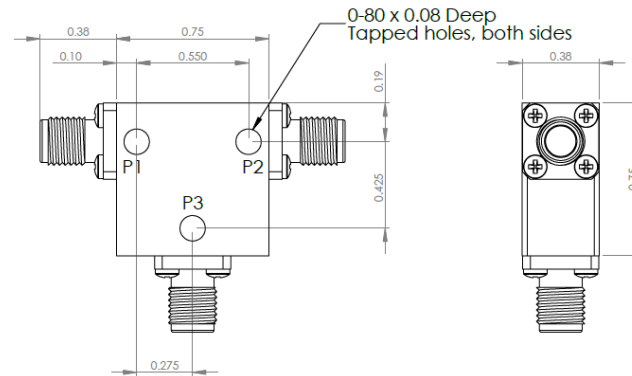

D3MC7011Y-77K-3

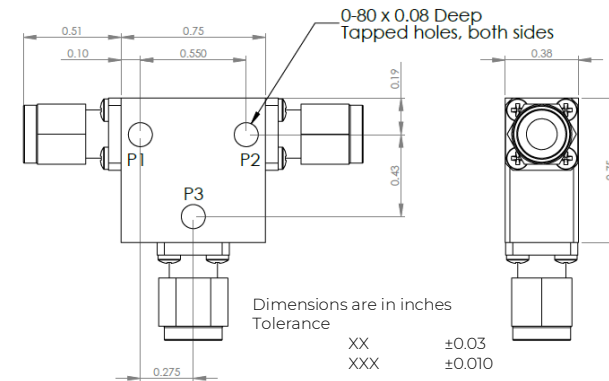

Type of Device	PN Suffix	Connector Configuration Port 1 / Port 2 / Port 3	PN Example
Single Junction 3-Port Device  Port 1 / Port 2 / Port 3	No Dash	Female / Female / Female	D3MC7011Y-77K
	-1	Male / Female / Female	D3MC7011Y-77K-1
	-2	Female / Male / Female	D3MC7011Y-77K-2
	-3	Male / Male / Male	D3MC7011Y-77K-3
	-4	Female / Female / Male	D3MC7011Y-77K-4
	-5	Male / Female / Male	D3MC7011Y-77K-5
	-6	Male / Male / Female	D3MC7011Y-77K-6
	-7	Female / Male / Male	D3MC7011Y-77K-7



## MEASURED DATA

Part Number: D3MC7011Y-77K, P1→P2, P3 Terminated with 50Ω, Measured at 77K

