



## Part Number: D4I3570

### Electrical Specifications

Frequency Range (GHz):	3.5 – 7.0
Isolation (dB):	34 MIN
Insertion Loss (dB):	1.0 MAX
VSWR:	1.35:1 MIN
Forward Power (W):	20 AVG 40 PK
Reflective Power (W):	2 AVG

### Mechanical/Environmental Specifications

Connector Type:	SMA
Connector Body:	Passivated stainless steel
Connector Pin:	Gold plated copper
Load Body:	Brass
Magnetic Shunt:	Nickel plated CRS
Operational Temp:	0°C to +50°C
Weight (oz)	4.0 MAX

### D4I3570 Dimensions

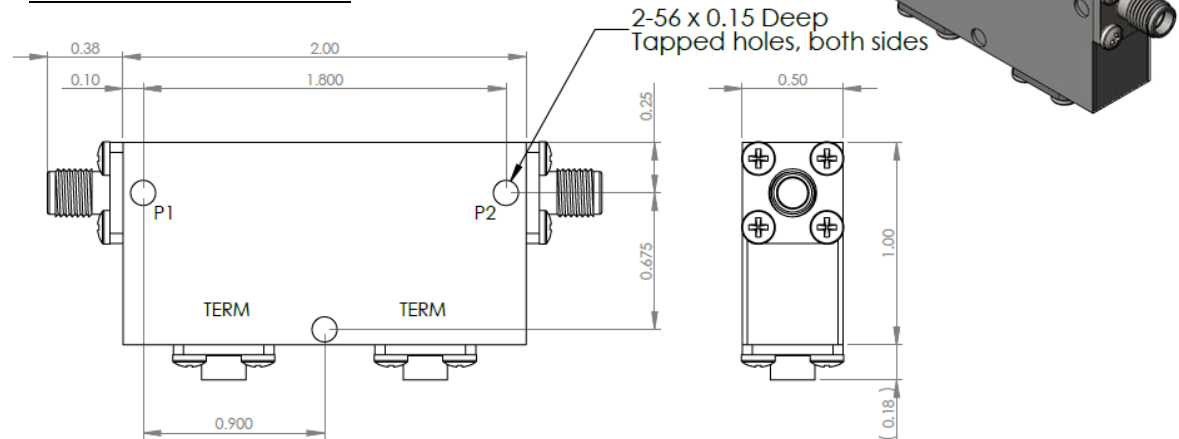

### D4I3570-3 Dimensions

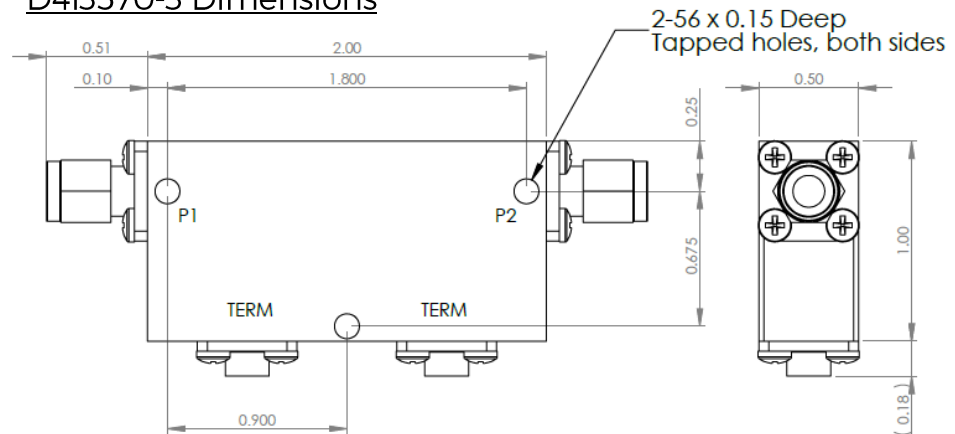

Dimensions are in inches  
Tolerance  
XX ±0.03  
XXX ±0.010

Type of Device	PN Suffix	Connector Configuration Input / Output	PN Example
Single and Dual Junction Isolator, 2-Port Device  Input / Output	N/A	Female / Female	D4I3570
	-1	Male / Female	D4I3570-1
	-2	Female / Male	D4I3570-2
	-3	Male / Male	D4I3570-3



# MEASURED DATA

Part Number: D4I3570, +25°C

