

Part Number: D4I8012Y

Electrical Specifications

Frequency Range (GHz):	8.0 – 12.0
Isolation (dB):	40 MIN
Insertion Loss (dB):	1.0 MAX
Return Loss (dB):	20 MIN
Forward Power (W):	25 AVG 500 PK
Reflective Power (W):	2 AVG

Mechanical/Environmental Specifications

Connector Type:	SMA
Connector Body:	Passivated stainless steel
Connector Pin:	Gold plated copper
Load Body:	Brass
Magnetic Shunt:	Nickel plated CRS
Operational Temp:	< 77K
Weight (oz)	4.0 MAX

D4I8012Y-2 Dimensions

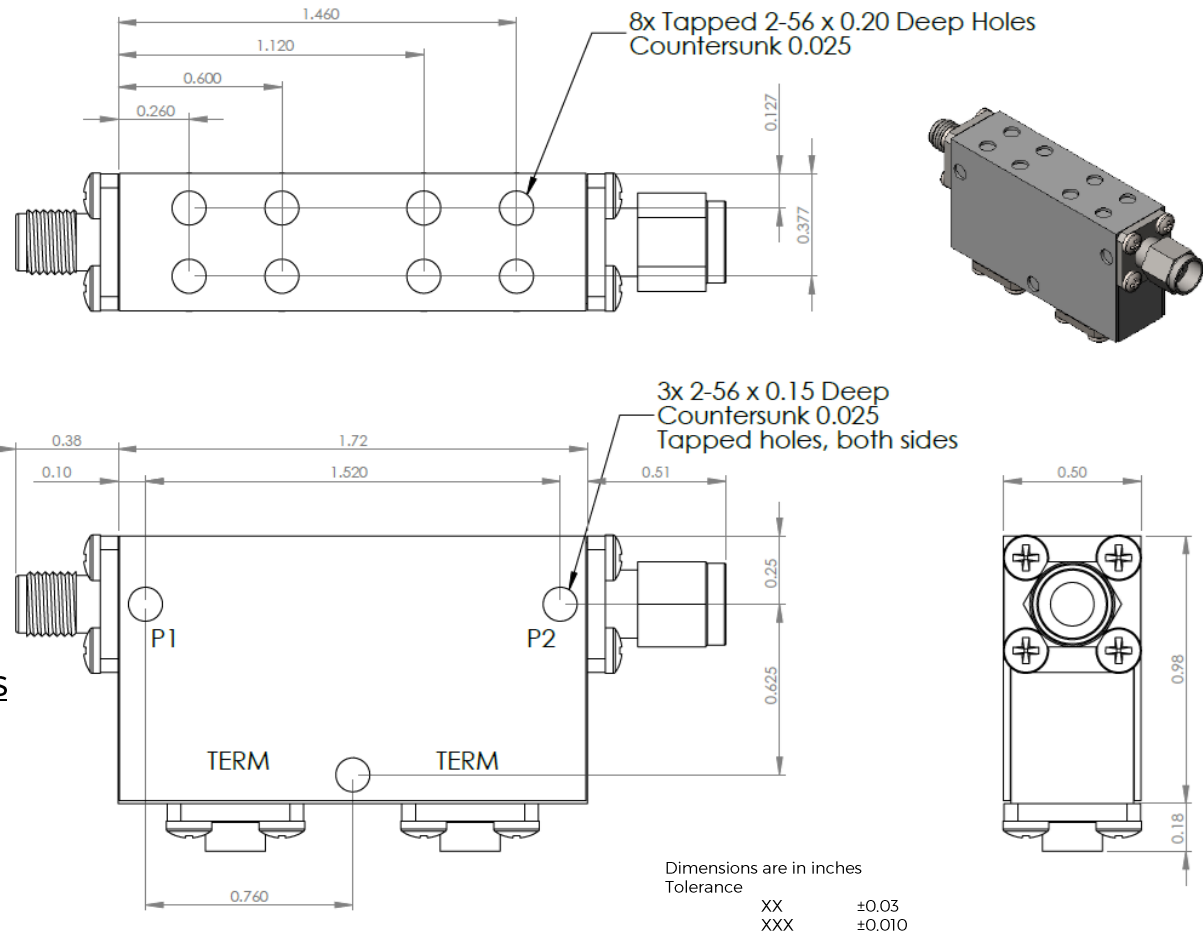

Type of Device	PN Suffix	Connector Configuration Input / Output	PN Example
Single and Dual Junction Isolator, 2-Port Device	N/A	Female / Female	D4I8012Y
	-1	Male / Female	D4I8012Y-1
	-2	Female / Male	D4I8012Y-2
	-3	Male / Male	D4I8012Y-3



MEASURED DATA

Part Number: D4I8012Y, Measured at 77K

