



Part Number: D4I4080YMG

Electrical Specifications

Frequency Range (GHz):	4.0 – 8.0
Isolation (dB):	32 MIN
Insertion Loss (dB):	0.8 MAX
Return Loss (dB):	16 MIN
Forward Power (W):	30 AVG 50 PK
Reflective Power (W):	2 AVG

Mechanical/Environmental Specifications

Connector Type:	SMA
Connector Body:	Passivated stainless steel
Connector Pin:	Gold plated copper
Load Body:	Brass
Magnetic Shunt:	Nickel plated CRS
Magnetically Shielded:	Yes
Operational Temp:	< 77K
Weight (oz)	4.0 MAX

D4I4080YMG-2 Dimensions

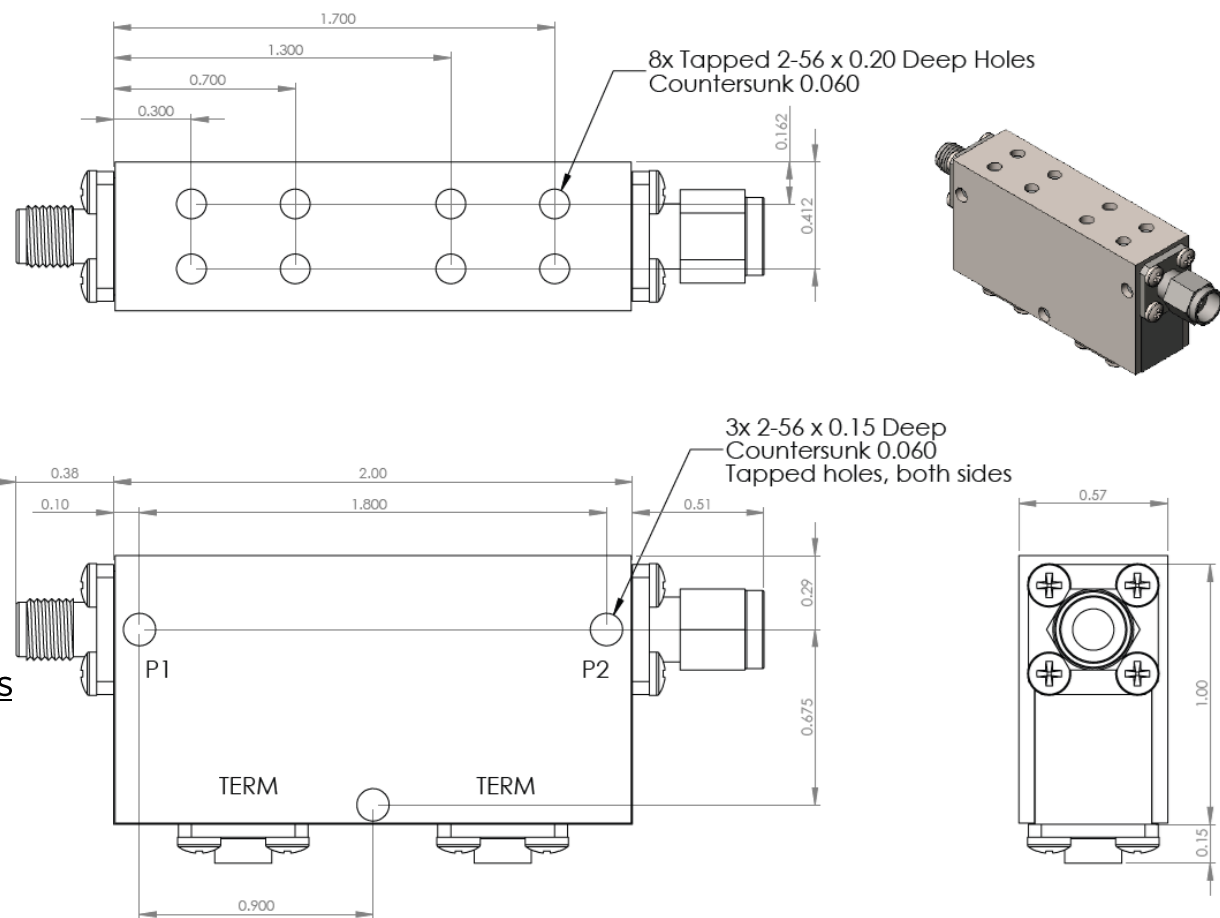

Type of Device	PN Suffix	Connector Configuration Input / Output	PN Example
Single and Dual Junction Isolator, 2-Port Device	N/A	Female / Female	D4I4080YMG
	-1	Male / Female	D4I4080YMG-1
	-2	Female / Male	D4I4080YMG-2
	-3	Male / Male	D4I4080YMG-3



MEASURED DATA

Part Number: D4I4080YMG, Measured at 77K

