



Part Number: D4C4012Y

Electrical Specifications

Frequency Range (GHz):	4.0 – 12.0	
Isolation (dB):	12	MIN (per junction)
Insertion Loss (dB):	1.0	MAX (per junction)
Return Loss (dB):	12	MIN (per junction)
Forward Power (W):	20	AVG
	30	PK

Mechanical/Environmental Specifications

Connector Type:	SMA
Connector Body:	Passivated stainless steel
Connector Pin:	Gold plated copper
Load Body:	Brass
Magnetic Shunt:	Nickel plated CRS
Operational Temp:	< 77K
Weight (oz)	4.0 MAX

D4C4012Y-2 Dimensions

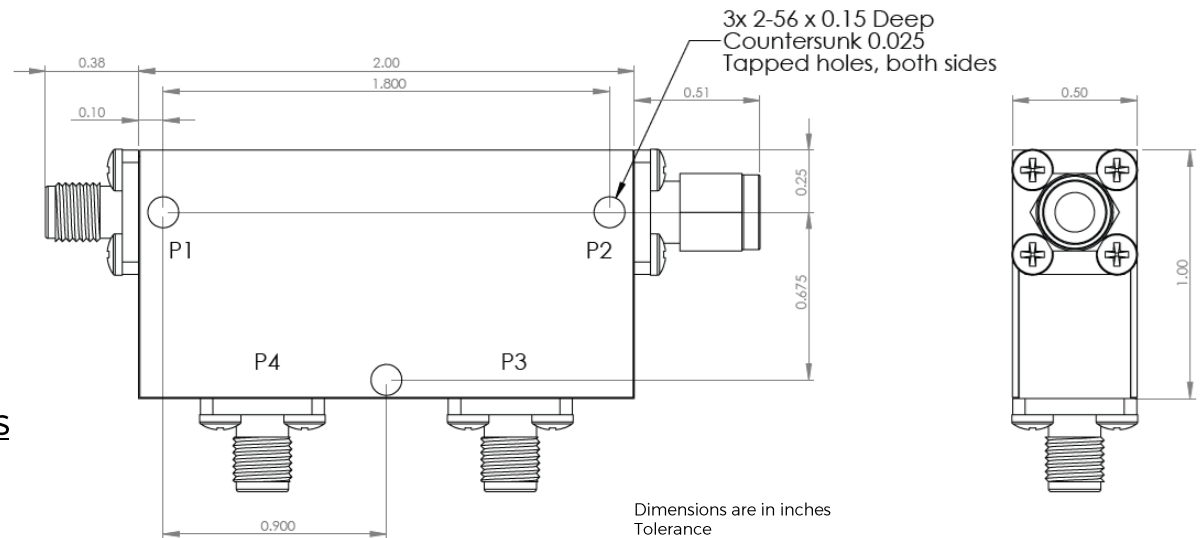
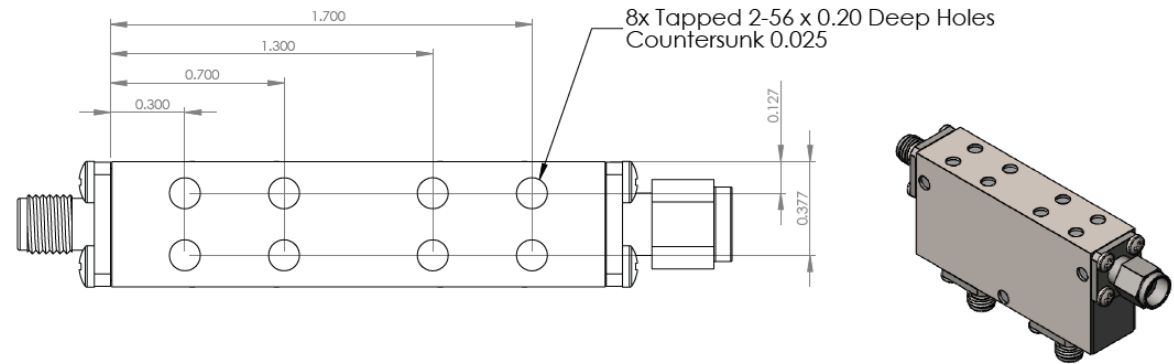

Dimensions are in inches
Tolerance
XX ±0.03
XXX ±0.010

Type of Device	PN Suffix	Connector Configuration Input / Output	PN Example
Dual Junction Circulator 4-Port Device Port 1 / Port 2 / Port 3 / Port 4	No Dash	Female / Female / Female / Female	D4C4012Y
	-1	Male / Female / Female / Female	D4C4012Y-1
	-2	Female / Male / Female / Female	D4C4012Y-2
	-3	Male / Male / Male / Male	D4C4012Y-3
	-4	Female / Female / Male / Female	D4C4012Y-4
	-5	Female / Female / Female / Male	D4C4012Y-5



MEASURED DATA

Part Number: D4C4012Y, P1→P2, P3 & P4 Terminated with 50Ω, Measured at 77K

