



## Part Number: D4I2060

### Electrical Specifications

Frequency Range (GHz):	2.0 – 6.0
Isolation (dB):	28 MIN
Insertion Loss (dB):	1.6 MAX
VSWR:	1.5:1 MIN
Forward Power (W):	20 AVG 20 PK
Reflective Power (W):	2 AVG

### Mechanical/Environmental Specifications

Connector Type:	SMA
Connector Body:	Passivated stainless steel
Connector Pin:	Gold plated copper
Load Body:	Brass
Magnetic Shunt:	Nickel plated CRS
Operational Temp:	0°C to +50°C
Weight (oz)	7.0 MAX

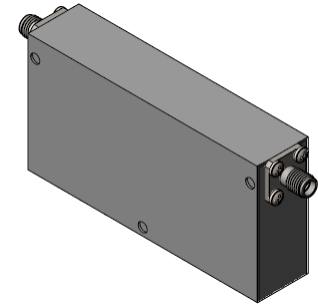

### D4I2060 Dimensions

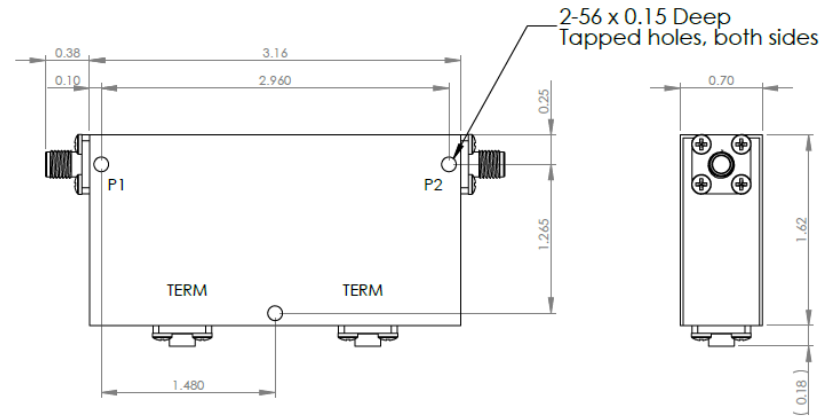

### D4I2060-3 Dimensions

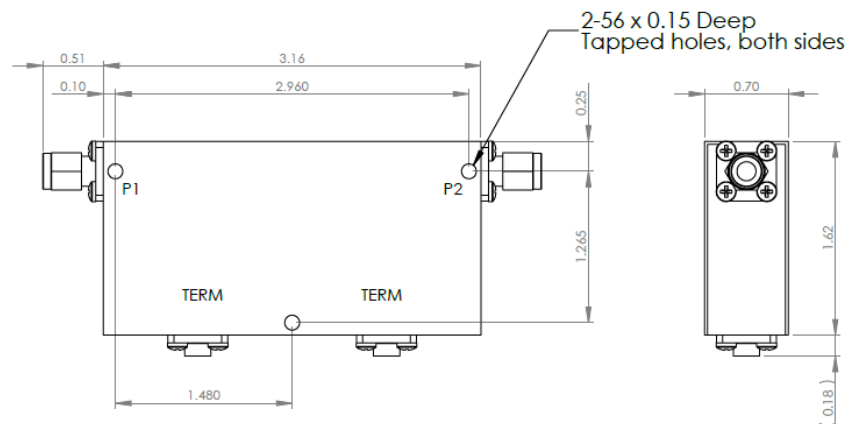

Dimensions are in inches  
Tolerance

XX	±0.03
XXX	±0.010

Type of Device	PN Suffix	Connector Configuration Input / Output	PN Example
Single and Dual Junction Isolator, 2-Port Device	N/A	Female / Female	D4I2060
	-1	Male / Female	D4I2060-1
	-2	Female / Male	D4I2060-2
	-3	Male / Male	D4I2060-3



# MEASURED DATA

Part Number: D4I2060, +25°C

