



Part Number: D4I1722N

Electrical Specifications

Frequency Range (GHz):	1.7 – 2.2
Isolation (dB):	40 MIN
Insertion Loss (dB):	0.8 MAX
VSWR:	1.25:1 MIN
Forward Power (W):	150 AVG 500 PK
Reflective Power (W):	10 AVG

Mechanical/Environmental Specifications

Connector Type:	Type-N
Connector Body:	Nickel plated brass
Connector Pin:	Gold plated copper
Load Body:	Brass
Magnetic Shunt:	Nickel plated CRS
Operational Temp:	-20°C to +65°C
Weight (oz)	5.5 MAX

D4I1722N Dimensions

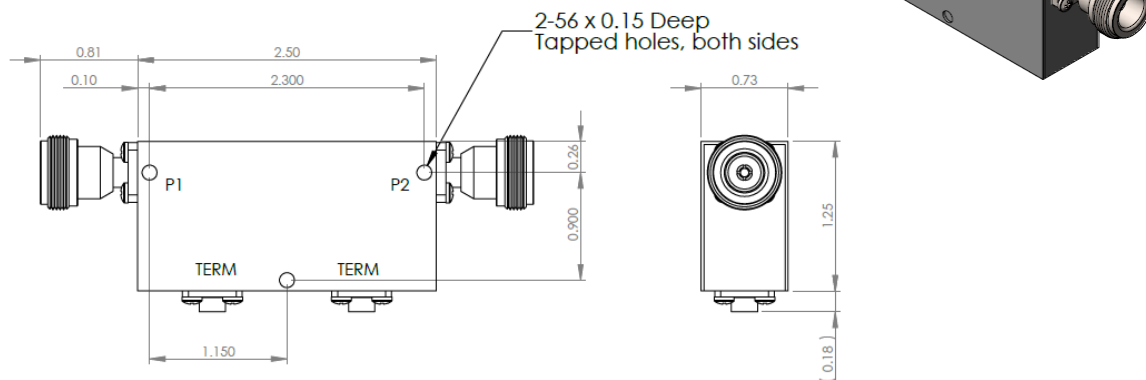

D4I1722N-3 Dimensions

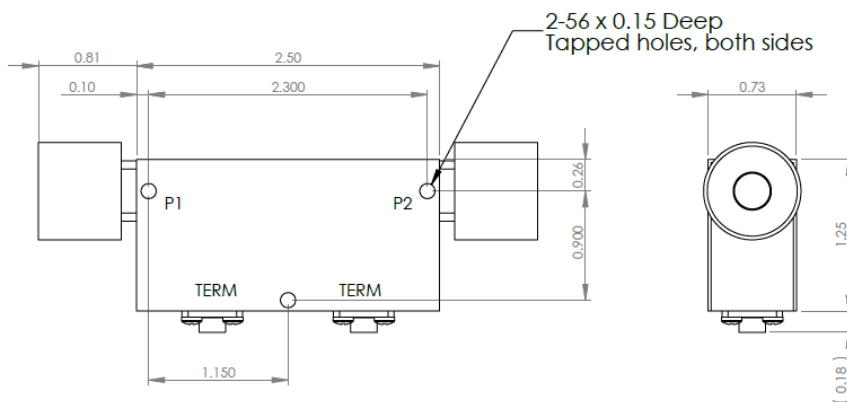

Dimensions are in inches
Tolerance

XX ±0.03
XXX ±0.010

Type of Device	PN Suffix	Connector Configuration Input / Output	PN Example
Single and Dual Junction Isolator, 2-Port Device Input / Output	N/A	Female / Female	D4I1722N
	-1	Male / Female	D4I1722N-1
	-2	Female / Male	D4I1722N-2
	-3	Male / Male	D4I1722N-3



MEASURED DATA

Part Number: D4I1722N, +25°C

