



## Part Number: D3C3442

### Electrical Specifications

Frequency Range (GHz):	3.4 – 4.2
Isolation (dB):	20 MIN
Insertion Loss (dB):	0.4 MAX
VSWR:	1.25:1 MIN
Forward Power (W):	20 AVG 30 PK

### Mechanical/Environmental Specifications

Connector Type:	SMA
Connector Body:	Passivated stainless steel
Connector Pin:	Gold plated copper
Load Body:	Brass
Magnetic Shunt:	Nickel plated CRS
Operational Temp:	-30°C to +65°C
Weight (oz)	2.0 MAX

### D3C3442 Dimensions

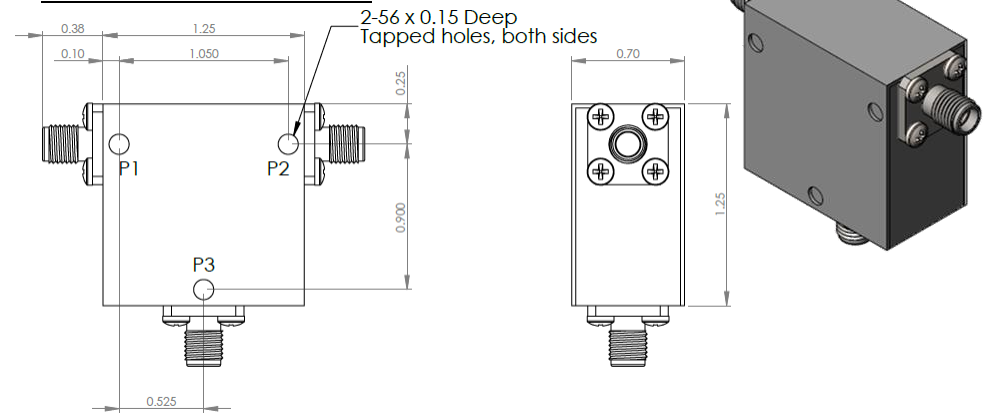

### D3C3442-3 Dimensions

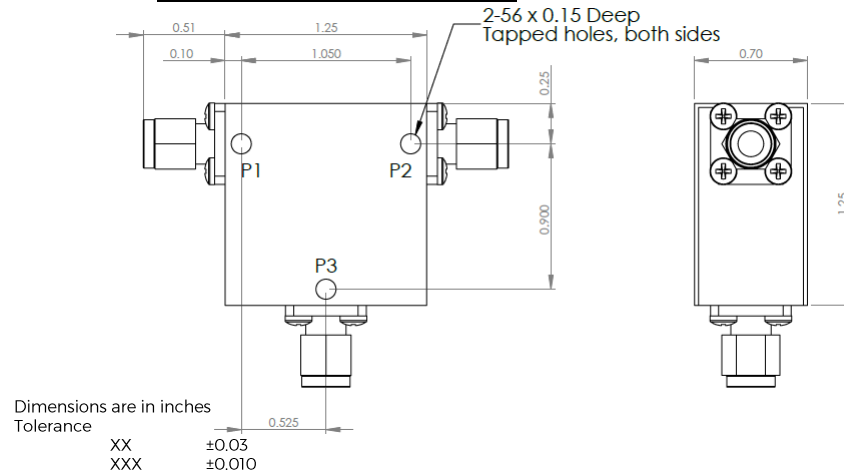

Type of Device	PN Suffix	Connector Configuration Input / Output	PN Example
Single Junction Circulator 3-Port Device Port 1 / Port 2 / Port 3	No Dash	Female / Female / Female	D3C3442
	-1	Male / Female / Female	D3C3442-1
	-2	Female / Male / Female	D3C3442-2
	-3	Male / Male / Male	D3C3442-3
	-4	Female / Female / Male	D3C3442-4
	-5	Male / Female / Male	D3C3442-5
	-6	Male / Male / Female	D3C3442-6
	-7	Female / Male / Male	D3C3442-7



## MEASURED DATA

Part Number: D3C3442, P1→P2, P3 Terminated with 50Ω, +25°C

